

# ETON SOUNDUPGRADE BMW INSTALLATION WIZZARD

## PASSIVE connection to original head unit (standard sound system)

In some BMW models of the E, F and G series, there are no tweeters installed in the standard sound system configuration. They can be retrofitted, however, the mirror tray or the window inner frame including mirror tray must be purchased and installed from BMW. Please ask your BMW dealer for the appropriate part numbers. If you do not want to install the tweeter, we recommend the use of a coaxial speaker (tweeter with midrange speaker in one unit).

All speakers are Plug & Play and have the matching BMW-specific connection plugs, i.e. you do not have to cut any cables or drill any holes! In the passive connection version you don't have to pull any new cables, all speakers are connected to the original BMW wiring harness. There are different speaker basket types, these are different in the mounting points, the contact surface, the basket depth and have different sealing surfaces. They have been developed to fit your door panel precisely, the following basket types are currently in use: Basket „N, -T, -W & -W2“, please refer to our compatibility list ([www.etongmbh.com](http://www.etongmbh.com)) for the appropriate speaker types for your vehicle. For all models we offer individually the B195 NEO under-seat basses.

In many models only one under-seat bass is installed, but we always recommend retrofitting the 2nd under-seat bass for optimum performance. Please note that an additional BMW B100 XHP high-pass crossover must be installed when operating the midrange speakers on the original wiring harness using the original head unit (without amplifier). This is not included in the package and must always be purchased separately. Included with the midrange speakers are the tweeter cable crossovers.

**Note about B100 XHP crossover:** Due to changes in impedance during the construction of the original BMW head units, acoustic errors may occur after installation of the B100 XHP. These are expressed by „cracking noises“ at high volumes -> Please note, these are not the speakers themselves, but faults in the head unit in conjunction with the B100 XHP crossovers. If you experience this error, please check the revision number of the B100 XHP crossovers. We have reacted to this error in combination with the BMW head units and created a modified version of the turnouts. The revision number „h“ fixes this error. You can exchange your turnouts free of charge at your specialist dealer at any time. Unfortunately, it is not possible to determine exactly which vehicles are affected by this error. Vehicles from the last series of the F-series as well as some vehicles from the G-series are increasingly affected. Please test the crossovers before refitting the door panel. In the course of production, the turnouts will all be converted to rev. „h“. Status 09/2020.

### PASSIVE CONNECTION LAYOUT

PLEASE NOTE THE CURRENT COMPATIBILITY LIST! [www.etongmbh.com](http://www.etongmbh.com)

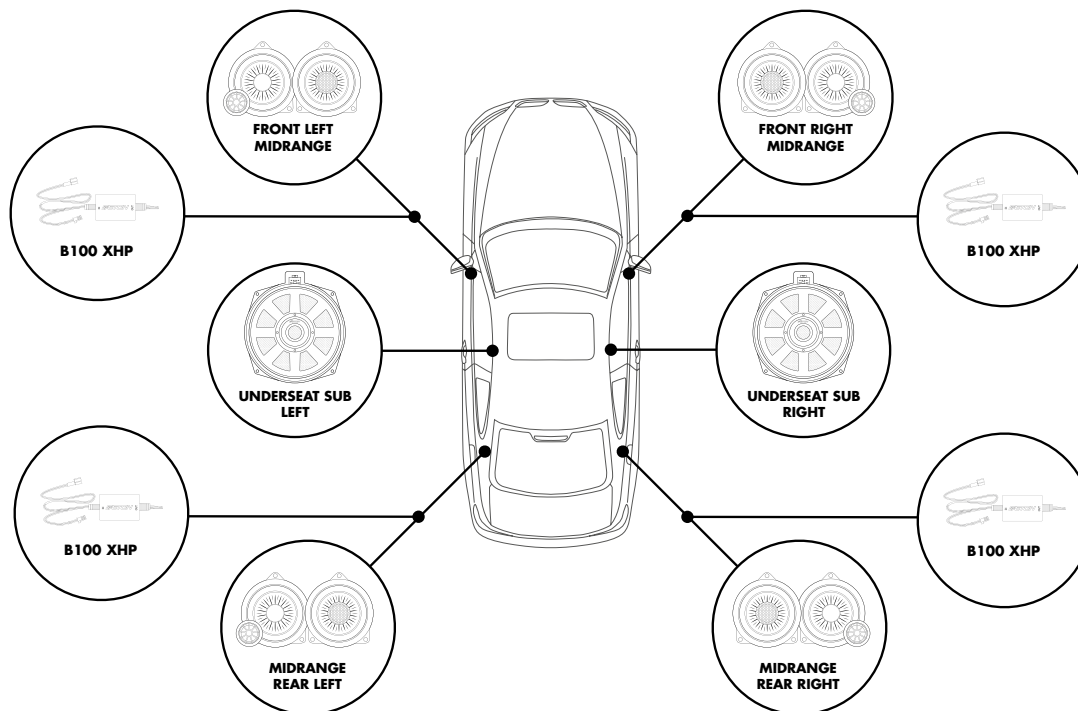

2-way systems

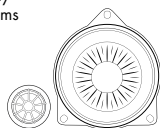

**B100 N**

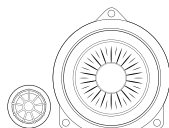

**B100 T**

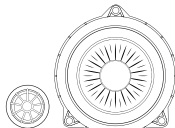

**B100 W**

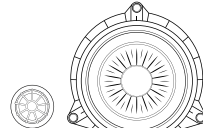

**B100 W2**

coaxial systems

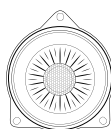

**B100 XN**

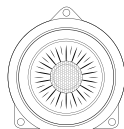

**B100 XT**

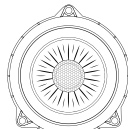

**B100 XW**

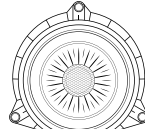

**B100 XW2**

Underseat-Subwoofer

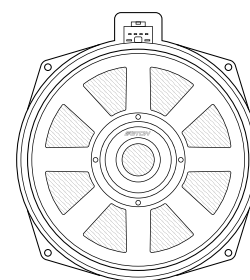

**B195 NEO**

High-pass crossover, for midrange drivers, not included in the set! Order separately!



**B100 XHP**

When passively connecting the speakers to the original radio with the standard wiring harness (without sound system), the BMW high-pass crossover B100 XHP must be installed for the midrange speakers! This is not included in the speaker set! Please note the information on the B100 XHP, status 09/2020.

**N-basket:** Screwing from the front, sealing surface on the back of the basket, „N=normal shoring“.

**T-basket:** Screwing from the rear, against the door panel, sealing surface on the front of the loudspeaker, „T=doorpanel shoring“.

**W-basket:** Raised basket height for optimum connection to the door trim, screw connection from the front, loudspeaker is screwed onto the inner door panel, sealing surface on the rear, loudspeaker projects into the wet area of the door.

**W2-basket:** Greatly extended basket height for optimum connection to the door trim, screw connection from the front, loudspeaker is screwed onto the inner door panel, sealing surface on the rear, loudspeaker protrudes into the wet area of the door. Wet area of the door „W2=Wet/wet installation, with extended basket depth“.

# ETON SOUNDUPGRADE BMW INSTALLATION WIZZARD

## PASSIVE connection to original head unit (standard sound system)

### WIRING LAYOUT

----- ORIGINAL BMW WIRING HARNESS

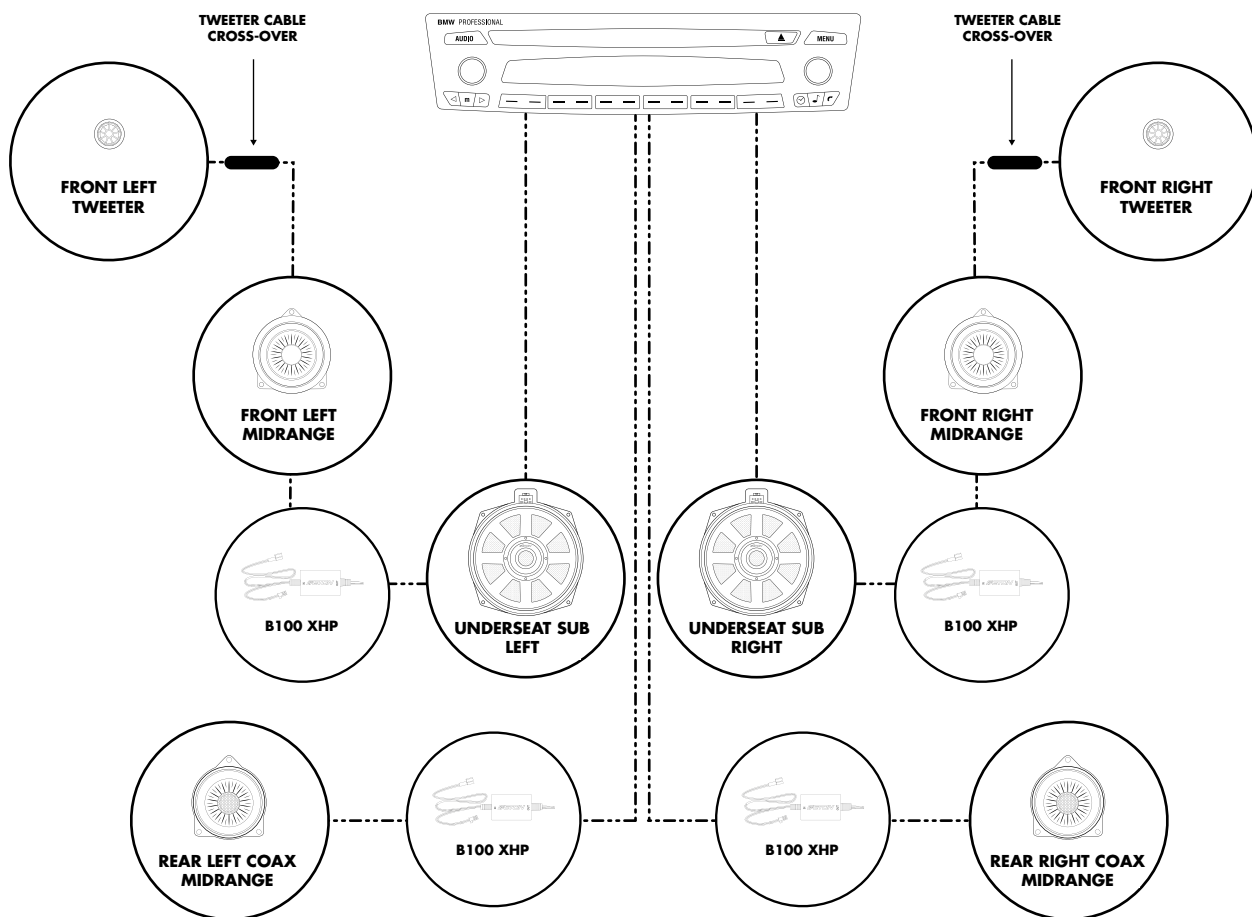

If active filtering is not available (passive connection to the standard radio / head unit without amplifier), the UG ETON BMW high-pass crossover B100 XHP must be installed in line of the midrange speakers! This is not included in the speaker set and must be purchased separately. (Please note the information on the B100 XHP as of 09/2020).

# ETON SOUNDUPGRADE BMW INSTALLATION WIZZARD

## PART-ACTIVE connection front system with 4-channel amplifier (standard sound system)

Please note the information contained in the passive connection on the previous pages. For partially active connection of the front speakers, the BAK (BMW connection cable kit) and a 4-channel amplifier are also required.

We recommend the use of an ETON MINI 150.4 or an ETON POWER 220.4 power amplifier. Both power amplifiers can be set with active filters for crossover frequencies, and channel-related levels/gains can also be set. If you want additional adjustment options, such as EQ adjustments or to set the running times of the individual speakers optimally, it is recommended to work with an ETON DSP power amplifier (ETON MINI 150.4 DSP / Stealth 7.1 DSP). Additional functions are here, integrated RTA (measuring device), streaming function, input mixer, EQ, running times and much more.

To connect the amplifier, lay appropriate power cables with fuse to the installation location of the amplifier (note the information from the operating instructions of the amplifier here). For simple signal tapping, please use the ETON BAK connection cable kit. This can be connected to the under-seat bass of the driver's and passenger's side in a plug & play procedure and taps the music signal for your amplifier.

The signal is taken from the subwoofers and fed to the amplifier, converted and amplified back into the original wiring harness. This means that no new loudspeaker cables need to be installed in the vehicle, and thanks to the vehicle-specific connectors, no cables need to be cut or damaged. All ETON amplifiers have integrated Hi-Level inputs and signal or DC detection, so there is no need for an additional remote line. Due to the active frequency filtering via the amplifier, the B100 XHP crossover required in the passive version is not necessary. However, please make sure to install the tweeter cable crossover included in the 2-way loudspeaker set!

### PART-ACTIVE CONNECTION LAYOUT

PLEASE NOTE THE CURRENT COMPATIBILITY LIST! [www.etongmbh.com](http://www.etongmbh.com)

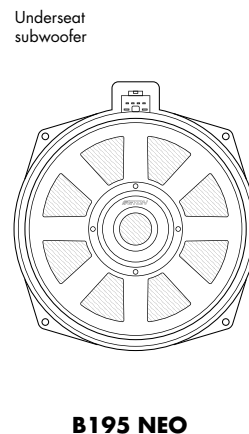
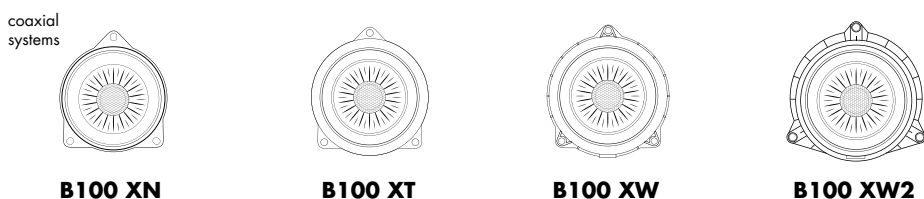
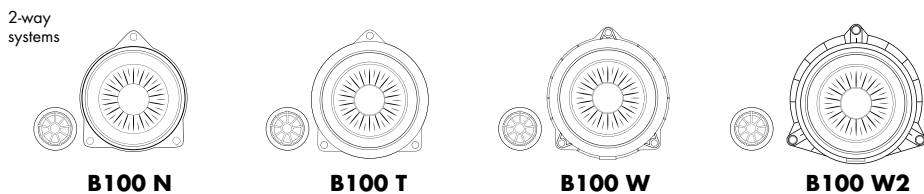
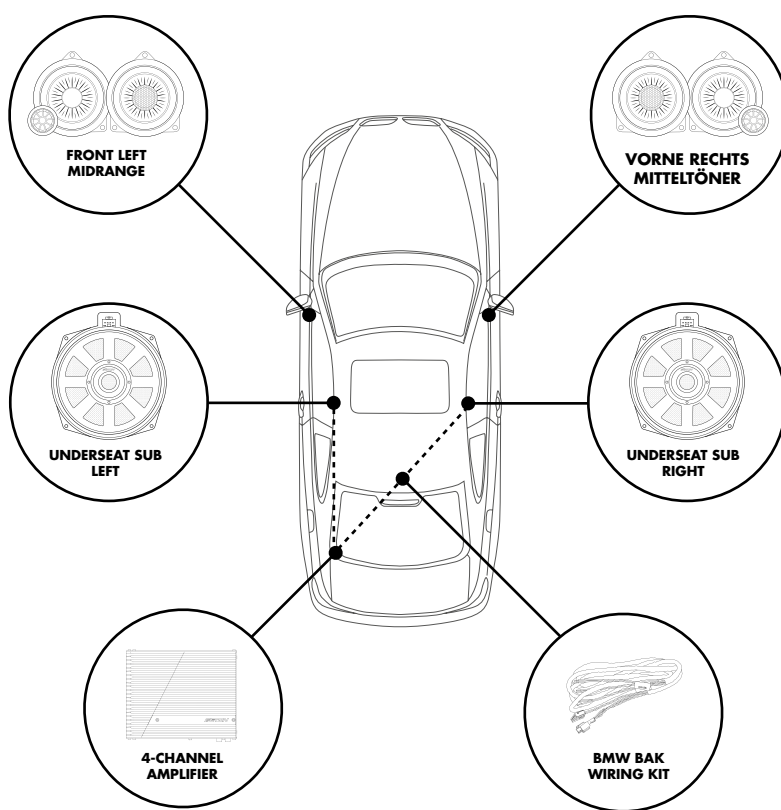

When passively connecting the speakers to the original radio with the standard wiring harness (without sound system), the BMW high-pass crossover B100 XHP must be installed for the midrange speakers! This is not included in the speaker set! Please note the information on the B100 XHP, status 09/2020.

- N-basket:** Screwing from the front, sealing surface on the back of the basket, „N=normal shoring“.
- T-basket:** Screwing from the rear, against the door panel, sealing surface on the front of the loudspeaker, „T=doorpanel shoring“.
- W-basket:** Raised basket height for optimum connection to the door trim, screw connection from the front, loudspeaker is screwed onto the inner door panel, sealing surface on the rear, loudspeaker projects into the wet area of the door.
- W2-basket:** Greatly extended basket height for optimum connection to the door trim, screw connection from the front, loudspeaker is screwed onto the inner door panel, sealing surface on the rear, loudspeaker protrudes into the wet area of the door. Wet area of the door „W2=Wet/wet installation, with extended basket depth“.

# ETON SOUNDUPGRADE BMW INSTALLATION WIZZARD

## PART-ACTIVE connection front system with 4-channel amplifier (standard sound system)

### WIRING LAYOUT

----- ORIGINAL BMW WIRING HARNESS  
 ——— ETON BAK WIRING HARNESS

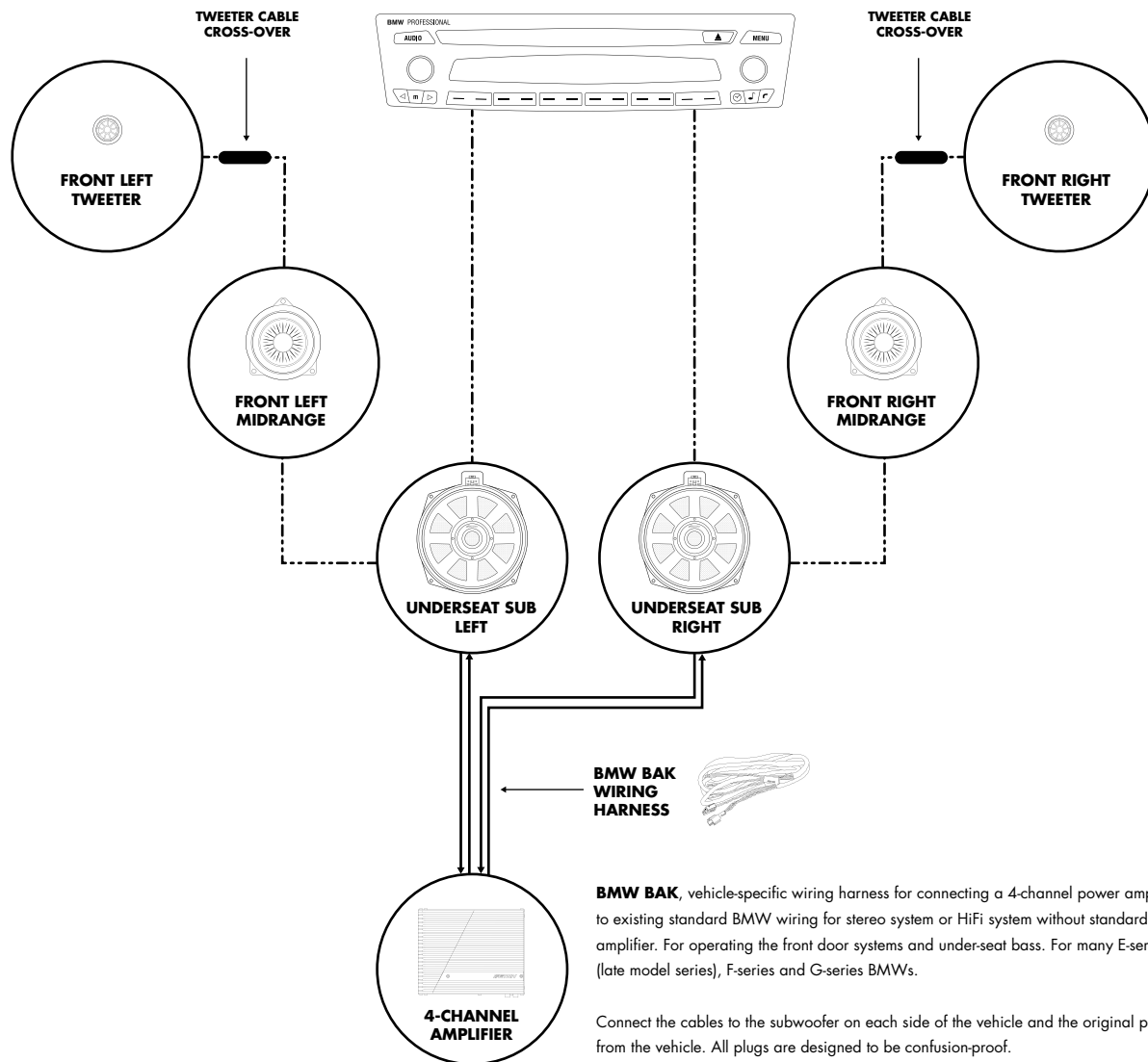

**BMW BAK**, vehicle-specific wiring harness for connecting a 4-channel power amplifier to existing standard BMW wiring for stereo system or HiFi system without standard amplifier. For operating the front door systems and under-seat bass. For many E-series (late model series), F-series and G-series BMWs.

Connect the cables to the subwoofer on each side of the vehicle and the original plugs from the vehicle. All plugs are designed to be confusion-proof.

### CONNECTION TO THE AMPLIFIER

#### OUTPUT

1. Connect BAK cable (left side) „MID-HIGH“ (blue + & blue-black -) with channel CH 1 Output
2. Connect BAK cable (right side) „MID-HIGH“ (blue + & blue-black -) with channel CH 2 Output
3. Connect BAK cable (left side) „WOOFER“ (white + & white-black -) with channel CH 3 Output
4. Connect BAK cable (right side) „WOOFER“ (white+ & white-black -) with channel CH 4 Output

#### INPUT

5. Connect BAK cable (left side) „INPUT“ (red-white + & black -) with High-Level CH1 Input
6. Connect BAK cable (right side) „INPUT“ (red-white + & black -) with High-Level CH2 Input

### CROSS-OVER FREQUENCIES SPEAKERS

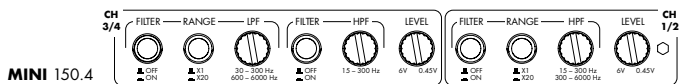

#### MIDRANGE-DRIVERS & TWEETERS CH1/2

1. Turn the amplifier to „DC“ auto-sense on function & choose „CH 1 | 2“ as input selection
2. Activate the active filters by pressing the „ON“ button.
3. Put the range at CH 1/2 to „X1“.
4. Turn the **highpass filter to 120 Hz**.
5. Adjust the gain CH1/2 (LEVEL 6V – 0.45V).

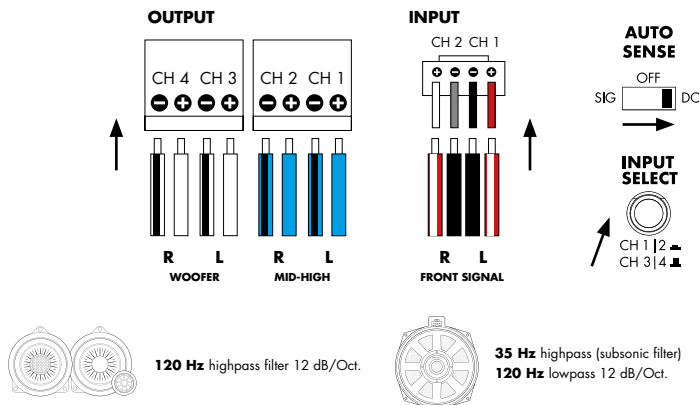

#### UNDERSEAT SUBWOOFERS CH3/4

6. Activate both active filters at CH3/4 by pressing the „ON“ button (HPF & LPF).
7. Adjust the **highpass filter (HPF/subsonic) to 35 Hz**.
8. Turn the range at CH 3/4 to „X1“.
9. Adjust the **lowpass filter (LPF) to 120 Hz**.
10. Adjust the gain CH 3/4 (LEVEL 6V – 0.45V).

# ETON SOUNDUPGRADE BMW INSTALLATION WIZZARD

## FULL-ACTIVE connection front system with 6-channel amplifier (standard sound system)

Please note the information contained in the passive connection on the previous pages. For fully active connection of the front speakers, the BAK (BMW connection cable kit) and a 6-channel amplifier with additional speaker cables for the tweeters are also required.

We recommend the use of an ETON POWER 150.6 or an ETON STEALTH 7.1 DSP power amplifier. Both power amplifiers can be set with active filters for crossover frequencies, and channel-related levels/gains can also be set. If you want additional adjustment options, such as EQ adjustments and to set the running times of the individual speakers optimally, we recommend working with an ETON DSP power amplifier (Stealth 7.1 DSP). Additional functions are here, integrated RTA (measuring device), streaming function, input mixer, EQ, running times and much more.

To connect the amplifier, lay appropriate power cables with fuse to the installation location of the amplifier (note the information from the operating instructions of the amplifier here). For simple signal tapping, please use the ETON BAK connection cable kit, which is plugged into the under-seat bass of the driver's and passenger's side and taps the music signal for your amplifier.

The signal is taken from the underseat subwoofers and fed to the amplifier, converted and amplified back into the original wiring harness. In addition, with the fully active tuning, two signal lines for the tweeters must be installed in the vehicle, i.e. you must lay two additional lines (we recommend twisted, full copper speaker cables in 0.75 sqmm cross-section with approx. 5 - 6 m cable length depending on the vehicle type and installation location of the amplifier) in the doors of your vehicle.

To do this, you should contact your BMW dealer to obtain the appropriate connection pins (4 x socket contact BMW 61 13 0 006 663 + 4 x pin contact BMW 61 13 0 006 664 ) for pinning into your door contact plug as well as 2 x plug connectors (BMW 8 373 577 with pins) for connecting the tweeters.

All ETON amplifiers have integrated Hi-Level inputs and signal or DC detection, so there is no need for an additional remote line. Thanks to the active frequency filtering via the amplifier, the cable crossovers for the tweeters and the B100 XHP midrange crossovers required in the passive version are no longer necessary.

### FULL-ACTIVE CONNECTION LAYOUT

PLEASE NOTE THE CURRENT COMPATIBILITY LIST! [www.etongmbh.com](http://www.etongmbh.com)

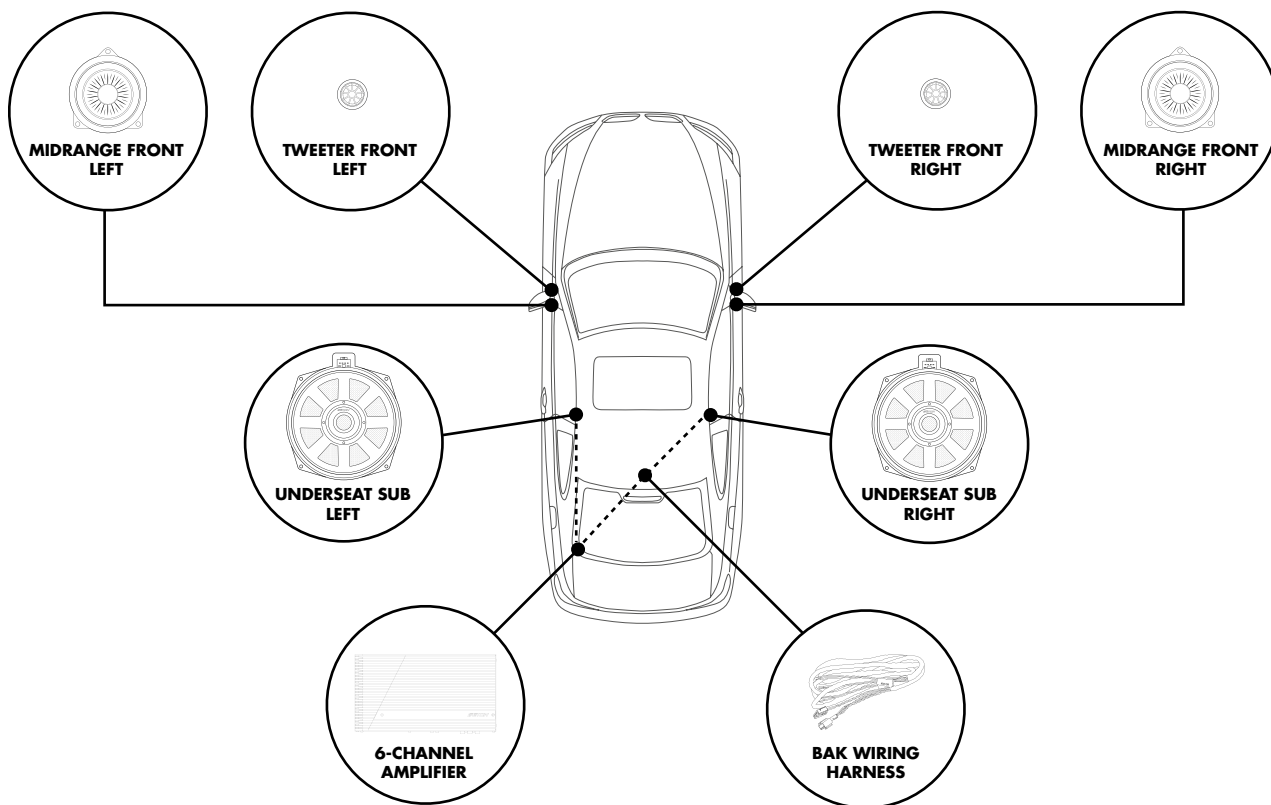

2-way systems

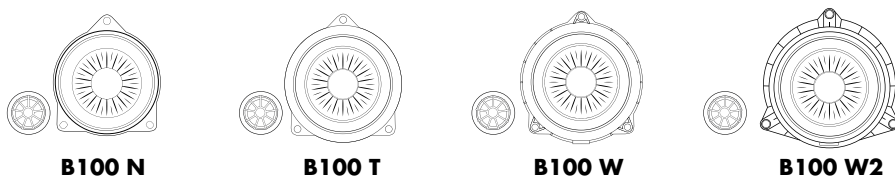

**N**-basket: Screwing from the front, sealing surface on the back of the basket, „N=normal shoring“.  
**T**-basket: Screwing from the rear, against the door panel, sealing surface on the front of the loudspeaker, „T=doorpanel shoring“.  
**W**-basket: Raised basket height for optimum connection to the door trim, screw connection from the front, loudspeaker projects into the wet area of the door panel, sealing surface on the rear, loudspeaker projects into the wet area of the door.  
**W2**-basket: Greatly extended basket height for optimum connection to the door trim, screw connection from the front, loudspeaker is screwed onto the inner door panel, sealing surface on the rear, loudspeaker protrudes into the wet area of the door. Wet area of the door „W2=Wet/wet installation, with extended basket depth“.

Underseat subwoofer

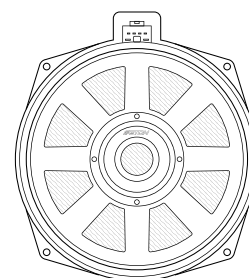

**B195 NEO**

Wiring harness



**BAK**

6-ch amplifier



**POWER 150.6**

# ETON SOUNDUPGRADE BMW INSTALLATION WIZZARD

## FULL-ACTIVE connection front system with 6-channel amplifier (standard sound system)

### WIRING LAYOUT

- ORIGINAL BMW WIRING HARNESS
- ETON BAK WIRING HARNESS
- - - - SEPARATE 0,75 sqmm TWEETER CABLE

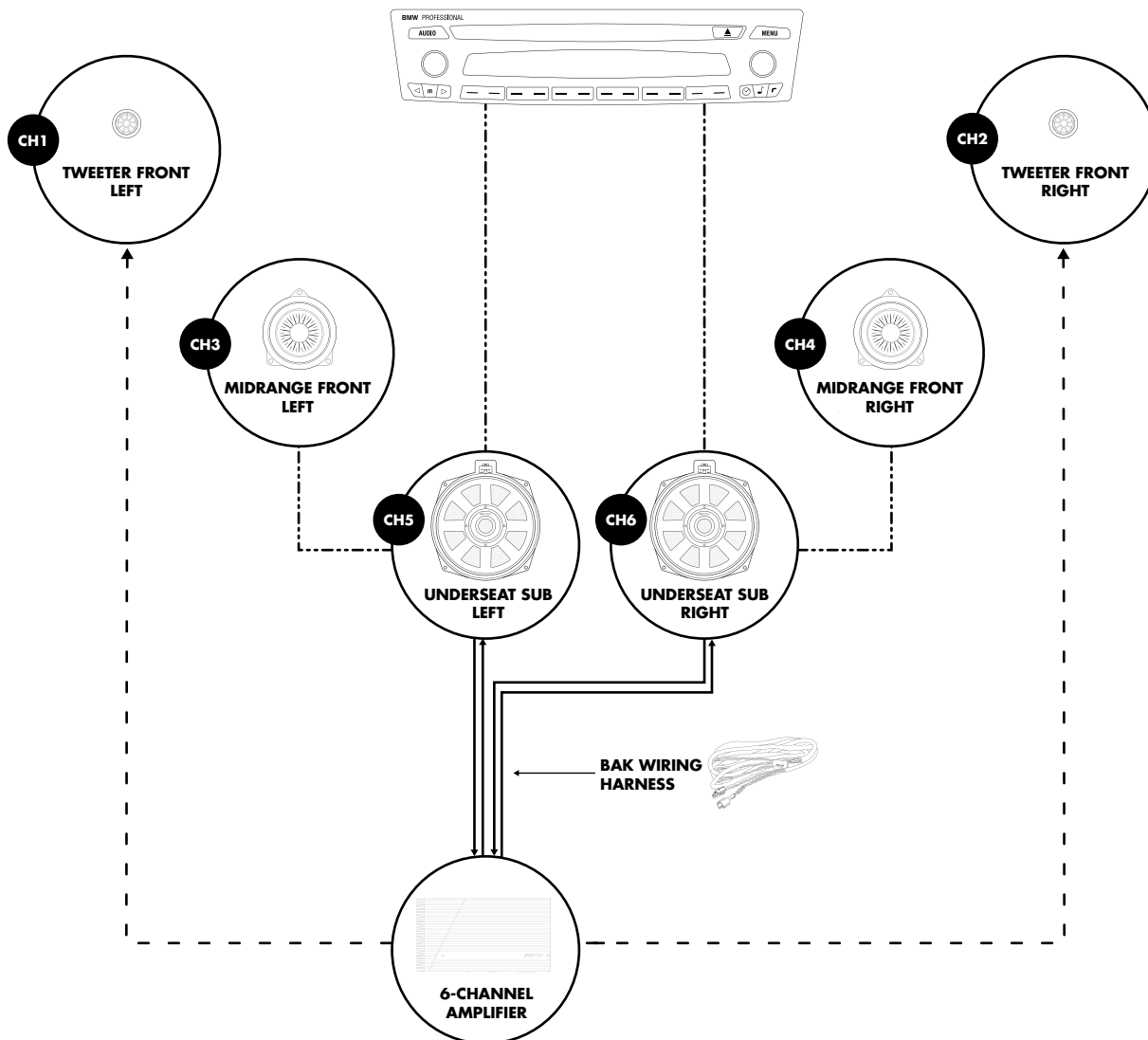

### CONNECTION TO THE AMPLIFIER

#### OUTPUT

1. Connect the tweeter cable (left side) (example colour pink + & pink-black -) to channel CH 1 Output
2. Connect the tweeter cable (right side) (example colour pink + & pink-black -) to channel CH 2 Output
3. Connect the BAK wiring harness (left side) „MID-HIGH“ (blue + & blue-black -) to channel CH 3 Output
4. Connect the BAK wiring harness (right side) „MID-HIGH“ (blue + & blue-black -) to channel CH 4 Output
5. Connect the BAK wiring harness (left side) „WOOFER“ (white + & white-black -) to channel CH 5 Output
6. Connect the BAK wiring harness (right side) „WOOFER“ (white + & white-black -) to channel CH 6 Output

#### INPUT

5. Connect the BAK wiring harness (left side) „INPUT“ (red-white + & black -) to Hi-Level CH1 Input
6. Connect the BAK wiring harness (right side) „INPUT“ (red-white + & black -) to Hi-Level CH2 Input

### CROSS-OVER FREQUENCIES SPEAKERS

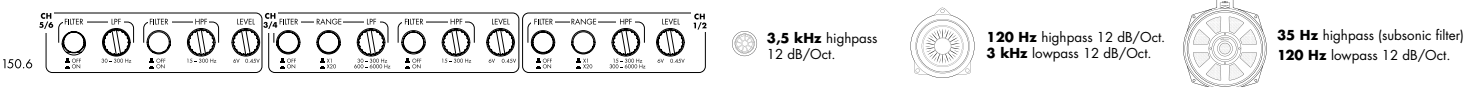

#### TWEETERS CH1/2

1. Turn the amplifier to „DC“ auto-sense on
2. Activate an active filter in CH 1/2 by pressing the „ON“ button.
3. Turn the range CH 1/2 to „X1“.
4. Adjust a **highpass filter** to **3500 Hz**.
5. Adjust the gain CH1/2 (LEVEL 6V – 0.45V).

#### MIDRANGE DRIVERS CH3/4

6. Activate an active filter in CH3/4 by pressing the „ON“ button (HPF & LPF) & choose „CH 1 | 2“ at 3/4 CH INPUT
7. Turn the range CH 3/4 LPF to „X20“.
8. Adjust the **lowpass filter (LPF)** to **3000 Hz**.
9. Adjust the **highpass filter (HPF)** to **120 Hz**.
10. Adjust the gain CH3/4 (LEVEL 6V – 0.45V).

#### UNDERSEAT SUBWOOFERS CH5/6

11. Activate an active filter in CH5/6 by pressing the „ON“ button (HPF & LPF) & choose „CH 1 | 2“ at 5/6 CH INPUT
12. Adjust the **highpass filter (HPF/subsonic)** to **35 Hz**.
13. Adjust the **lowpass filter (LPF)** to **120 Hz**.
14. Adjust the gain CH 5/6 (LEVEL 6V – 0.45V).

#### OUTPUT



#### INPUT

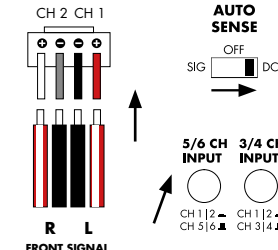

# ETON SOUNDUPGRADE BMW INSTALLATION WIZZARD

## FULL-ACTIVE connection front system + center speaker with 7-channel DSP amplifier (standard sound system)

Please refer to the information contained in the passive connection on the previous pages. For fully active connection of the front speakers + centre speaker, the BAK (BMW connection cable kit) and a 7-channel amplifier with additional speaker cables for the tweeters and the centre speaker are also required.

We recommend the use of an ETON STEALTH 7.1 DSP power amplifier, this enables optimum power distribution (asymmetrical power distribution) and offers numerous setting options: Adjustment of crossover frequencies, input & output EQ, integrated RTA measuring device (RTA 3.5 measuring microphone available separately), runtime adjustment, HiRes WiFi streaming and much more. For the connection of the amplifier, lay appropriate power cables with fuse to the installation location of the amplifier (note the information from the operating instructions of the amplifier here). For simple signal tapping, please use the ETON BAK connection cable kit. This is plugged in plug & play on the under-seat bass of the driver's and passenger's side and taps the music signal for your amplifier.

The signal is taken from the basses and fed to the amplifier, converted and amplified back into the original wiring harness. In addition, with 3-way front system fully active tuning + center speaker, two signal lines for the tweeters and one signal line for the center speaker must be installed in the vehicle, i.e. you must lay three additional lines (we recommend twisted, full copper loudspeaker cables with a cross-section of 0.75 sqmm and a cable length of approx. 5 - 6 m, depending on the vehicle type and the installation location of the amplifier) in the doors and in the dashboard of your vehicle.

To do this, you should contact your BMW dealer to obtain the appropriate connection pins (4 x socket contact BMW 61 13 0 006 663 + 4 x pin contact BMW 61 13 0 006 664 ) to pin into your door contact plug as well as 2 x connectors (BMW 8 373 577 with pins) for connecting the tweeters and 1 x connector BMW 6925630-01 for the centre speaker. The matching centre speaker cover is also required.

All ETON amplifiers have integrated Hi-Level inputs and signal or DC recognition. detection, so there is no need for an additional remote line. Thanks to the active frequency filtering via the amplifier, there is no need for the cable crossovers required in the passive version.

### FULL ACTIVE FRONT SYSTEM + CENTER

PLEASE NOTE THE CURRENT COMPATIBILITY LIST! [www.etongmbh.com](http://www.etongmbh.com)

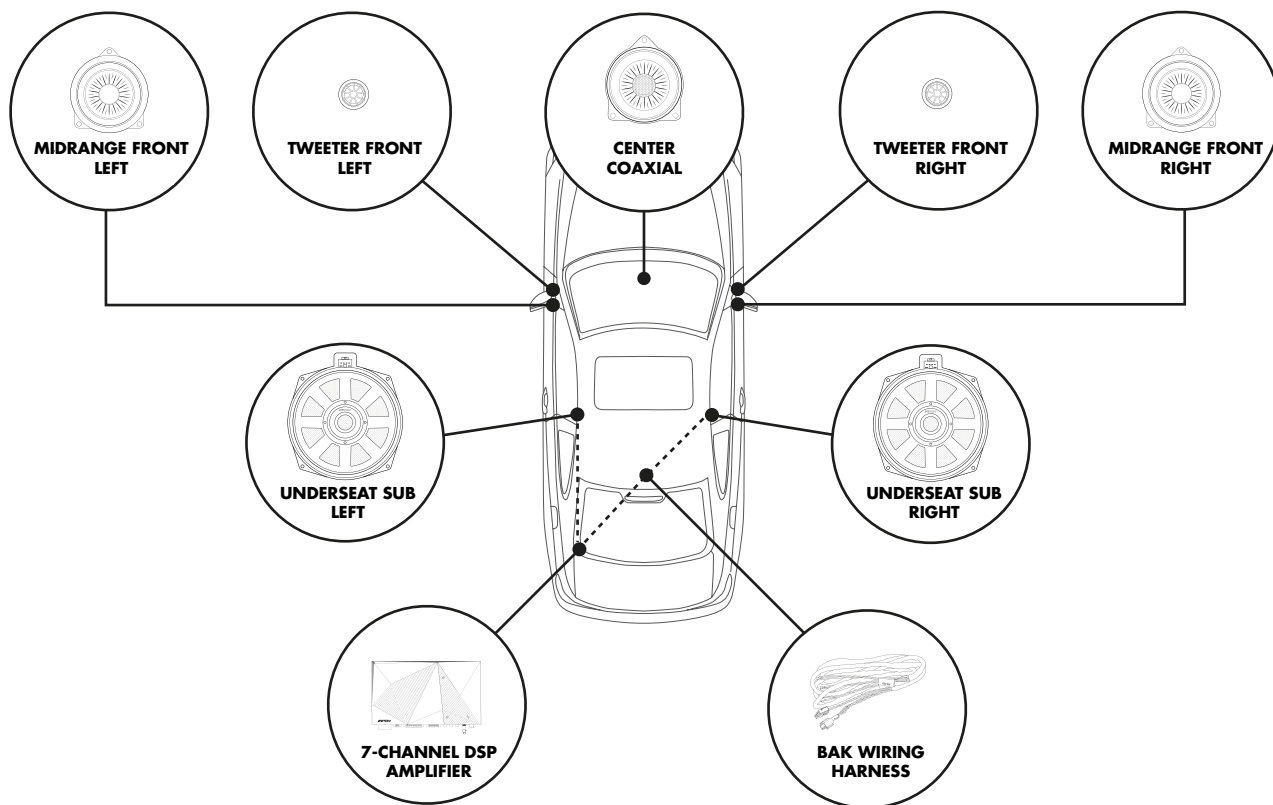

2-way systems

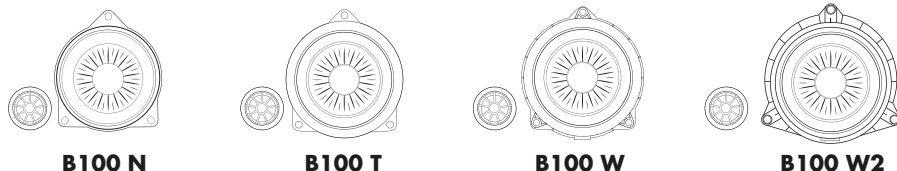

**N**-basket: Screwing from the front, sealing surface on the back of the basket, „N=normal shoring“.  
**T**-basket: Screwing from the rear, against the door panel, sealing surface on the front of the loudspeaker, „T=doorpanel shoring“.  
**W**-basket: Raised basket height for optimum connection to the door trim, screw connection from the front, loudspeaker is screwed onto the inner door panel, sealing surface on the rear, loudspeaker projects into the wet area of the door.  
**W2**-basket: Greatly extended basket height for optimum connection to the door trim, screw connection from the front, loudspeaker is screwed onto the inner door panel, sealing surface on the rear, loudspeaker protrudes into the wet area of the door. Wet area of the door „W2=Wet/wet installation, with extended basket depth“.

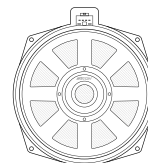

**B195 NEO**

Underseat subwoofer

Wiring harness



**BAK**

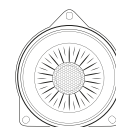

**B100 XCN**

Single center coaxial speaker

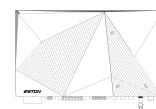

**STEALTH 7.1 DSP**

7-channel amplifier

# ETON SOUNDUPGRADE BMW INSTALLATION WIZZARD

**FULL-ACTIVE connection front system + center speaker with 7-channel DSP amplifier (standard sound system)**

## WIRING LAYOUT

- ORIGINAL BMW WIRING HARNESS
- ETON BAK WIRING HARNESS
- - - - SEPARATE 0,75 sqmm TWEETER CABLE
- ..... SEPARATE 0,75 sqmm CENTER CABLE

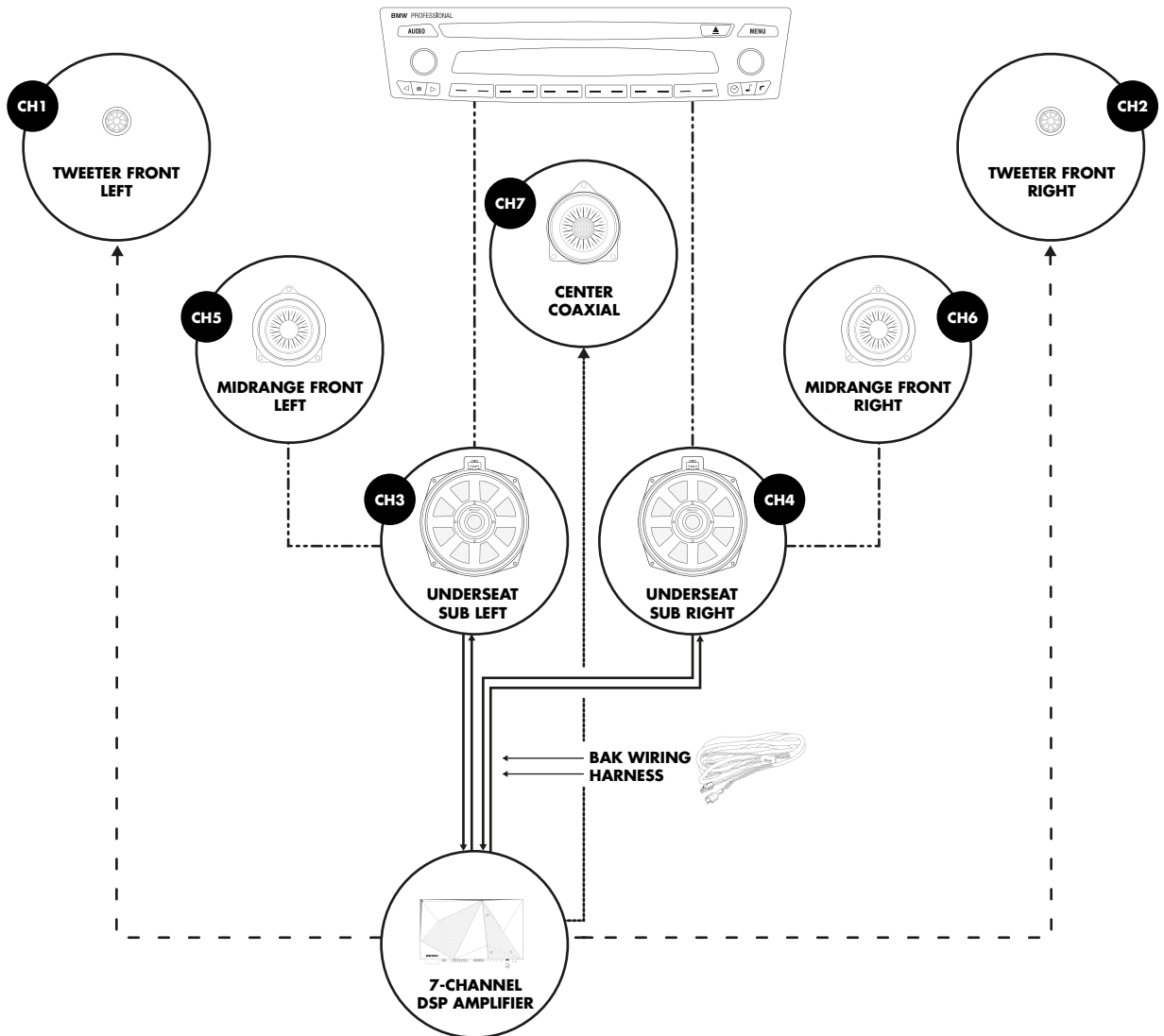

## CONNECTION TO THE AMPLIFIER

### OUTPUT

1. Connect the tweeter cable (left side) (Example colour pink + & pink-black -) to CH 1 Output
2. Connect the tweeter cable (right side) (Example colour pink + & pink-black -) to CH 2 Output
3. Connect the BAK wiring harness (left side) „WOOFER“ (white + & white-black -) to CH 3 Output
4. Connect the BAK wiring harness (right side) „WOOFER“ (white + & white-black -) to CH 4 Output
5. Connect the BAK wiring harness (left side) „MID-HIGH“ (blue + & blue-black -) to CH 5 Output
6. Connect the BAK wiring harness (right side) „MID-HIGH“ (blue + & blue-black -) to CH 6 Output
7. Connect the center cable (Example colour green + & green-black -) to CH 7 Output

### INPUT

5. Connect the BAK wiring harness (left side) „INPUT“ (red-white + & black -) to Hi-Level CH1 input
6. Connect the BAK wiring harness (right side) „INPUT“ (red-white + & black -) to Hi-Level CH2 input

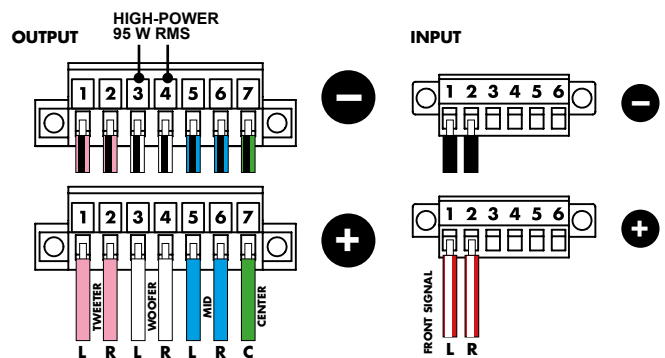

## CROSSOVER FREQUENCIES SPEAKERS

### TWEETERS

**3,5 kHz** highpass  
12 dB/Oct.

### MIDRANGE DRIVERS

**120 Hz** highpass 12 dB/Oct.  
**3 kHz** lowpass 12 dB/Oct.

### CENTER

**120 Hz** highpass 12 dB/Oct.

### UNDERSEAT SUBWOOFERS

**35 Hz** highpass (subsonic filter)  
**120 Hz** lowpass 12 dB/Oct.

